

PDP SWITCH

IRFB4233PbF

Features

- Advanced process technology
- Key parameters optimized for PDP Sustain, Energy Recovery and Pass Switch Applications
- Low E_{PULSE} rating to reduce power dissipation in PDP Sustain, Energy Recovery and Pass Switch Applications
- Low Q_G for fast response
- High repetitive peak current capability for reliable operation
- Short fall & rise times for fast switching
- 175°C operating junction temperature for improved ruggedness
- Repetitive avalanche capability for robustness and reliability

Key Parameters		
V_{DS} min	230	V
V_{DS} (Avalanche) typ.	276	V
$R_{DS(ON)}$ typ. @ 10V	31	mΩ
I_{RP} max @ $T_C = 100^\circ\text{C}$	114	A
T_J max	175	°C

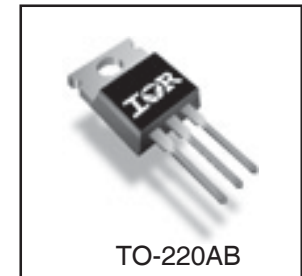
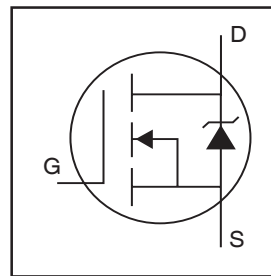

Description

This HEXFET[®] Power MOSFET is specifically designed for Sustain; Energy Recovery & Pass switch applications in Plasma Display Panels. This MOSFET utilizes the latest processing techniques to achieve low on-resistance per silicon area and low E_{PULSE} rating. Additional features of this MOSFET are 175°C operating junction temperature and high repetitive peak current capability. These features combine to make this MOSFET a highly efficient, robust and reliable device for PDP driving applications.

Absolute Maximum Ratings

	Parameter	Max.	Units
V_{GS}	Gate-to-Source Voltage	±30	V
I_D @ $T_C = 25^\circ\text{C}$	Continuous Drain Current, V_{GS} @ 10V	56	A
I_D @ $T_C = 100^\circ\text{C}$	Continuous Drain Current, V_{GS} @ 10V	39	
I_{DM}	Pulsed Drain Current ①	220	
I_{RP} @ $T_C = 100^\circ\text{C}$	Repetitive Peak Current ⑤	114	
P_D @ $T_C = 25^\circ\text{C}$	Power Dissipation	370	W
P_D @ $T_C = 100^\circ\text{C}$	Power Dissipation	190	
	Linear Derating Factor	2.5	W/°C
T_J	Operating Junction and	-40 to + 175	°C
T_{STG}	Storage Temperature Range		
	Soldering Temperature for 10 seconds	300	
	Mounting Torque, 6-32 or M3 Screw	10lb·in (1.1N·m)	N

Thermal Resistance

	Parameter	Typ.	Max.	Units
$R_{\theta JC}$	Junction-to-Case ④	—	0.402	°C/W
$R_{\theta CS}$	Case-to-Sink, Flat, Greased Surface	0.50	—	
$R_{\theta JA}$	Junction-to-Ambient ④	—	62	

Notes ① through ⑥ are on page 8

Electrical Characteristics @ $T_J = 25^\circ\text{C}$ (unless otherwise specified)

	Parameter	Min.	Typ.	Max.	Units	Conditions
BV_{DSS}	Drain-to-Source Breakdown Voltage	230	—	—	V	$V_{GS} = 0V, I_D = 250\mu A$
$\Delta BV_{DSS}/\Delta T_J$	Breakdown Voltage Temp. Coefficient	—	200	—	mV/°C	Reference to $25^\circ\text{C}, I_D = 1mA$
$R_{DS(on)}$	Static Drain-to-Source On-Resistance	—	31	37	m Ω	$V_{GS} = 10V, I_D = 28A$ ③
$V_{GS(th)}$	Gate Threshold Voltage	3.0	—	5.0	V	$V_{DS} = V_{GS}, I_D = 250\mu A$
$\Delta V_{GS(th)}/\Delta T_J$	Gate Threshold Voltage Coefficient	—	-14	—	mV/°C	
I_{DSS}	Drain-to-Source Leakage Current	—	—	5.0	μA	$V_{DS} = 184V, V_{GS} = 0V$
		—	—	150		$V_{DS} = 184V, V_{GS} = 0V, T_J = 125^\circ\text{C}$
I_{GSS}	Gate-to-Source Forward Leakage	—	—	100	nA	$V_{GS} = 20V$
	Gate-to-Source Reverse Leakage	—	—	-100		$V_{GS} = -20V$
g_{fs}	Forward Transconductance	83	—	—	S	$V_{DS} = 25V, I_D = 39A$
Q_g	Total Gate Charge	—	120	170	nC	$V_{DD} = 115V, I_D = 39A, V_{GS} = 10V$ ③
Q_{gd}	Gate-to-Drain Charge	—	44	—		
$t_{d(on)}$	Turn-On Delay Time	—	31	—	ns	$V_{DD} = 115V, V_{GS} = 10V$ ③
t_r	Rise Time	—	71	—		$I_D = 39A$
$t_{d(off)}$	Turn-Off Delay Time	—	51	—		$R_G = 5\Omega$
t_f	Fall Time	—	41	—		See Fig. 22
t_{st}	Shoot Through Blocking Time	100	—	—	ns	$V_{DD} = 184V, V_{GS} = 15V, R_G = 4.7\Omega$
E_{PULSE}	Energy per Pulse	—	460	—	μJ	$L = 220nH, C = 0.4\mu F, V_{GS} = 15V$ $V_{DS} = 184V, R_G = 4.7\Omega, T_J = 25^\circ\text{C}$
		—	970	—		$L = 220nH, C = 0.4\mu F, V_{GS} = 15V$ $V_{DS} = 184V, R_G = 4.7\Omega, T_J = 100^\circ\text{C}$
C_{iss}	Input Capacitance	—	5510	—	pF	$V_{GS} = 0V$
C_{oss}	Output Capacitance	—	480	—		$V_{DS} = 25V$
C_{rss}	Reverse Transfer Capacitance	—	220	—		$f = 1.0MHz,$
$C_{oss\ eff.}$	Effective Output Capacitance	—	340	—		$V_{GS} = 0V, V_{DS} = 0V \text{ to } 184V$
L_D	Internal Drain Inductance	—	4.5	—	nH	Between lead, 6mm (0.25in.)
L_S	Internal Source Inductance	—	7.5	—		from package and center of die contact

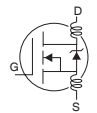

Avalanche Characteristics

	Parameter	Typ.	Max.	Units
E_{AS}	Single Pulse Avalanche Energy ②	—	250	mJ
E_{AR}	Repetitive Avalanche Energy ①	—	39	mJ
$V_{DS(Avalanche)}$	Repetitive Avalanche Voltage ①	276	—	V
I_{AS}	Avalanche Current ②	—	39	A

Diode Characteristics

	Parameter	Min.	Typ.	Max.	Units	Conditions
$I_S @ T_C = 25^\circ\text{C}$	Continuous Source Current (Body Diode)	—	—	56	A	MOSFET symbol showing the integral reverse p-n junction diode.
I_{SM}	Pulsed Source Current (Body Diode) ①	—	—	220		
V_{SD}	Diode Forward Voltage	—	—	1.0	V	$T_J = 25^\circ\text{C}, I_S = 39A, V_{GS} = 0V$ ③
t_{rr}	Reverse Recovery Time	—	190	280	ns	$T_J = 25^\circ\text{C}, I_F = 39A, V_{DD} = 50V$
Q_{rr}	Reverse Recovery Charge	—	760	1140	nC	$di/dt = 100A/\mu s$ ③

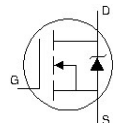

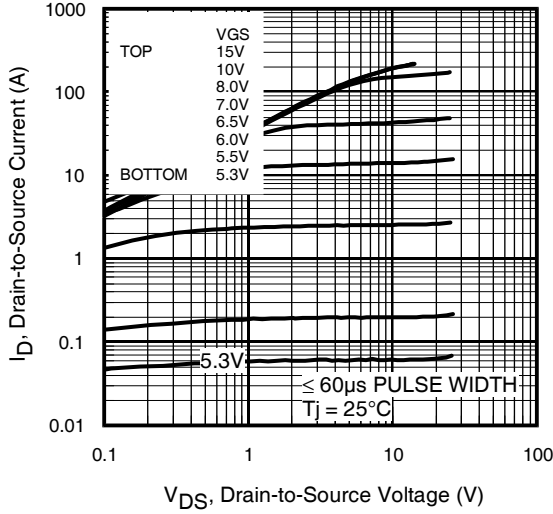

Fig 1. Typical Output Characteristics

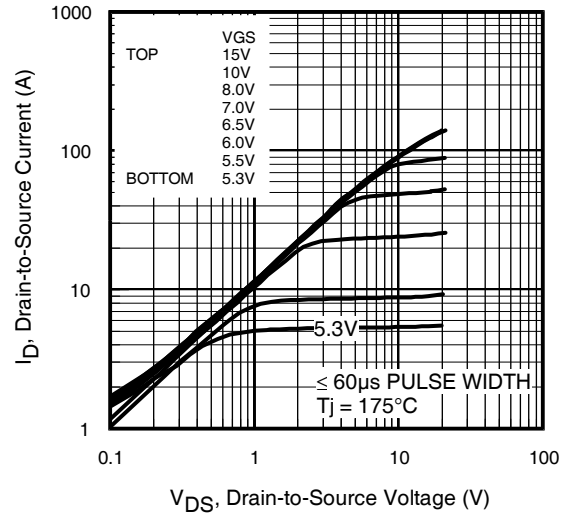

Fig 2. Typical Output Characteristics

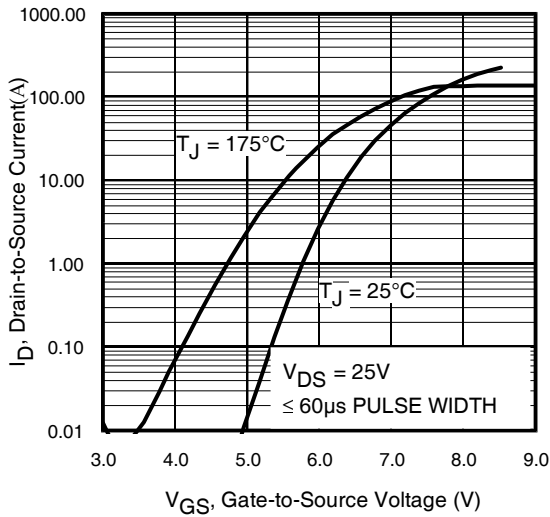

Fig 3. Typical Transfer Characteristics

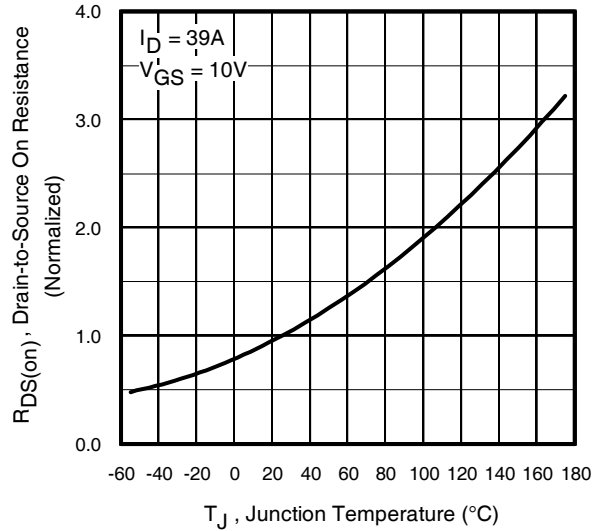

Fig 4. Normalized On-Resistance vs. Temperature

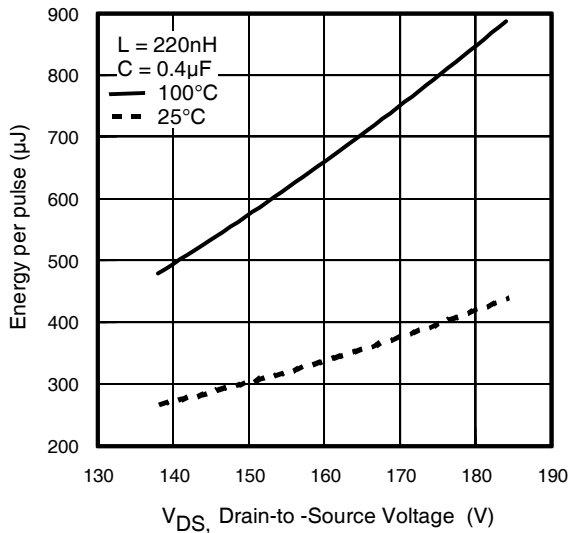

Fig 5. Typical E_{PULSE} vs. Drain-to-Source Voltage

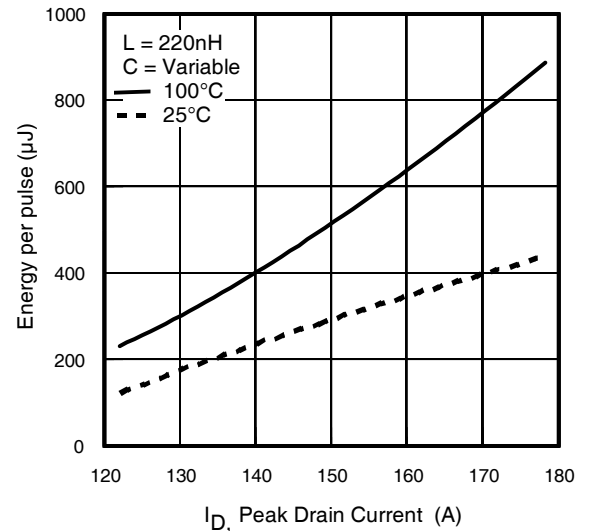

Fig 6. Typical E_{PULSE} vs. Drain Current

IRFB4233PbF

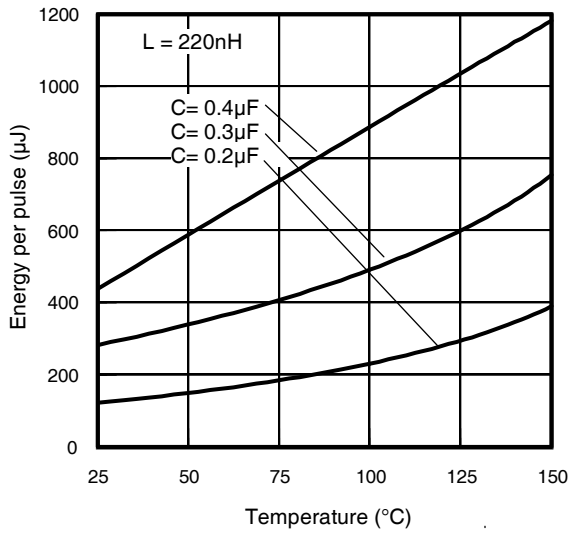

Fig 7. Typical E_{PULSE} vs. Temperature

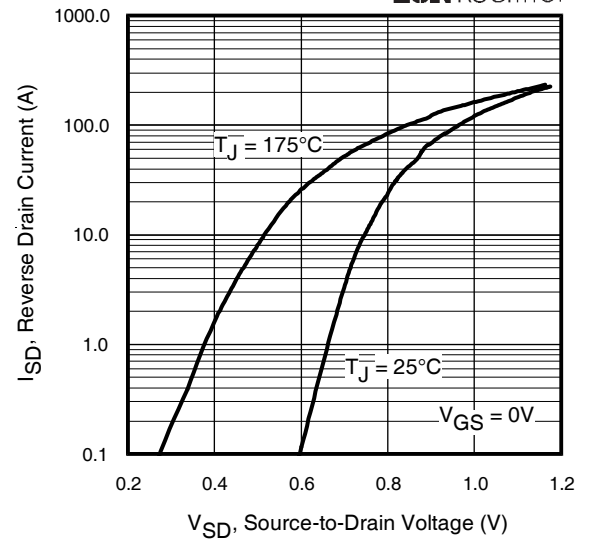

Fig 8. Typical Source-Drain Diode Forward Voltage

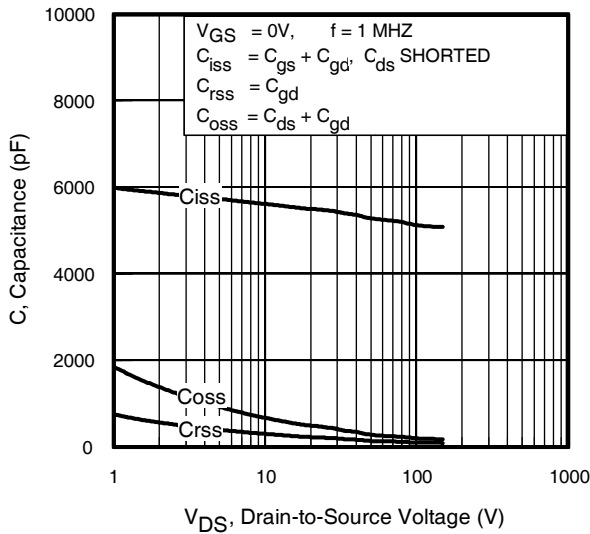

Fig 9. Typical Capacitance vs. Drain-to-Source Voltage

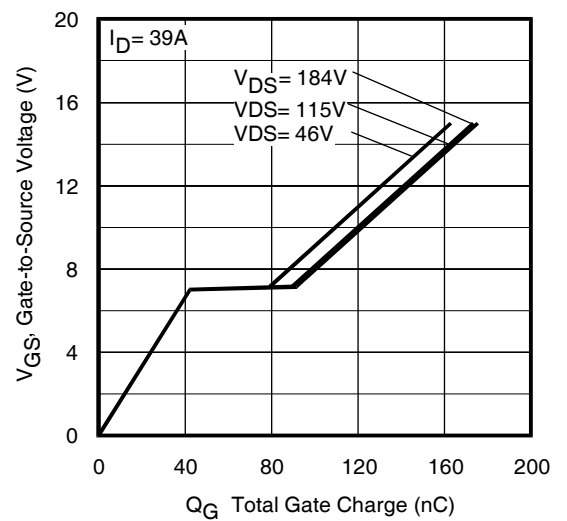

Fig 10. Typical Gate Charge vs. Gate-to-Source Voltage

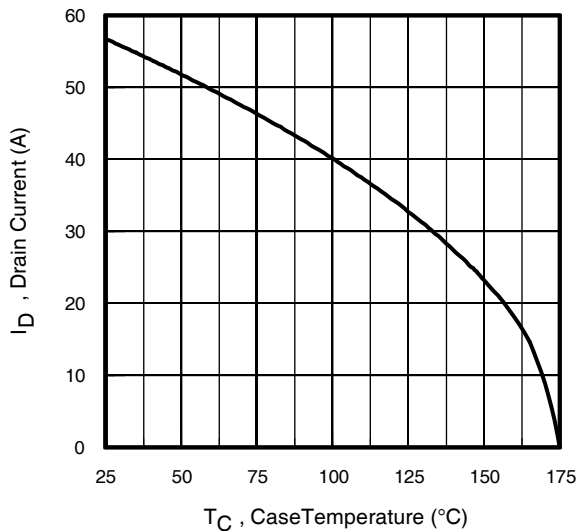

Fig 11. Maximum Drain Current vs. Case Temperature

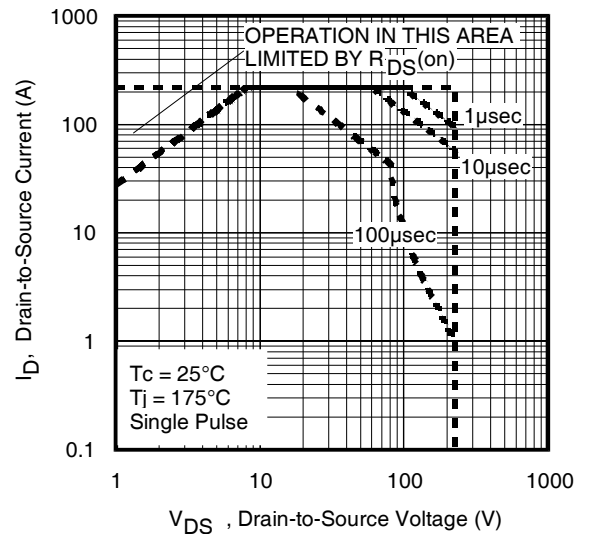

Fig 12. Maximum Safe Operating Area

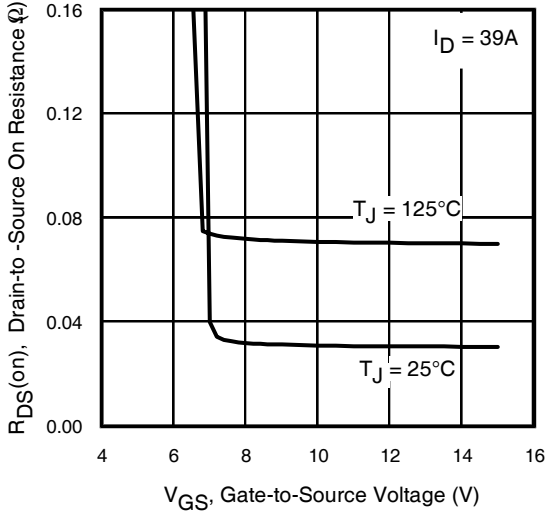

Fig 13. On-Resistance Vs. Gate Voltage

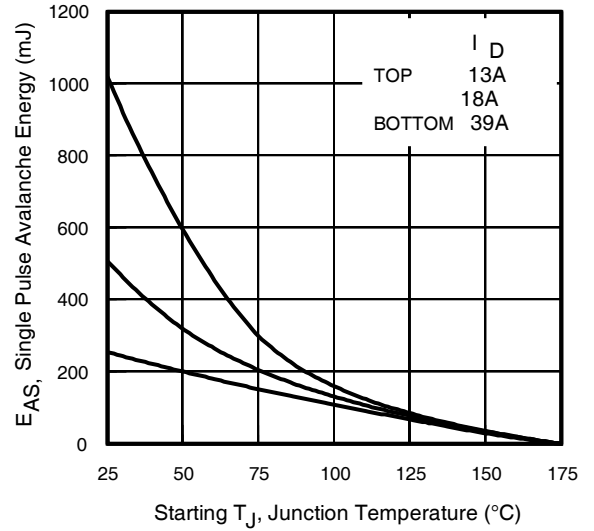

Fig 14. Maximum Avalanche Energy Vs. Temperature

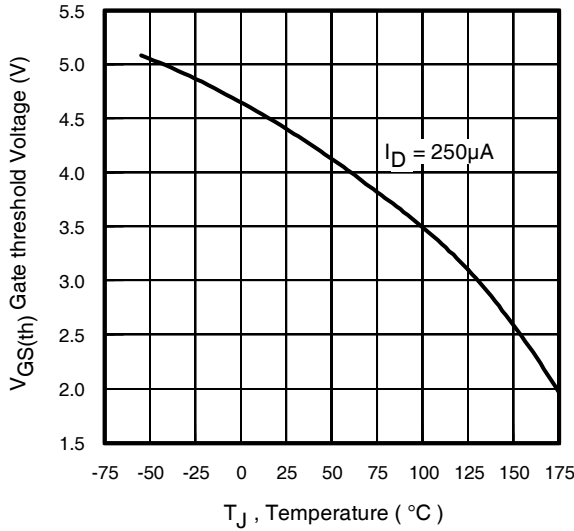

Fig 15. Threshold Voltage vs. Temperature

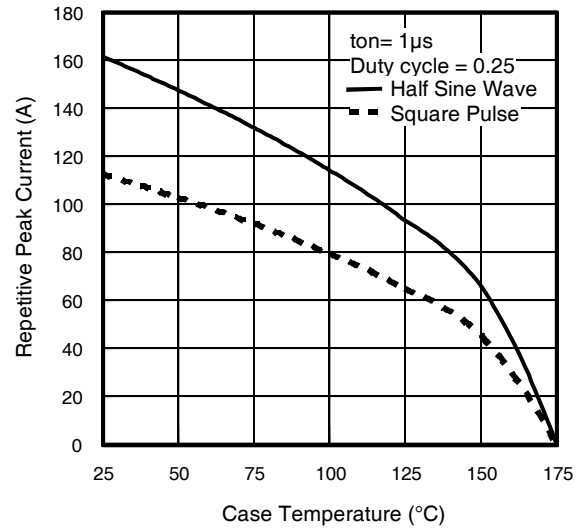

Fig 16. Typical Repetitive peak Current vs. Case temperature

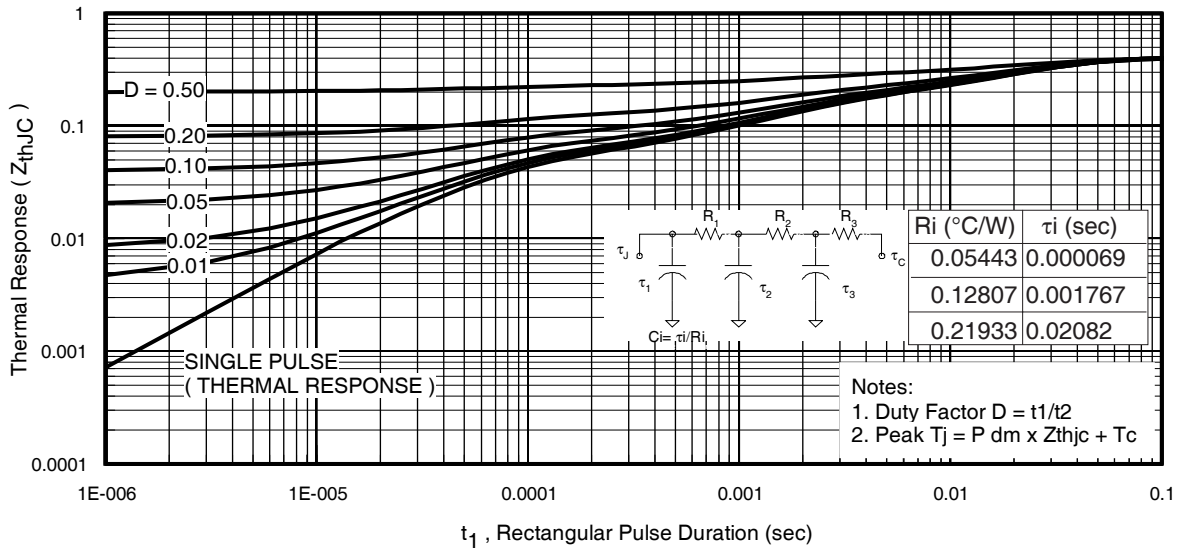
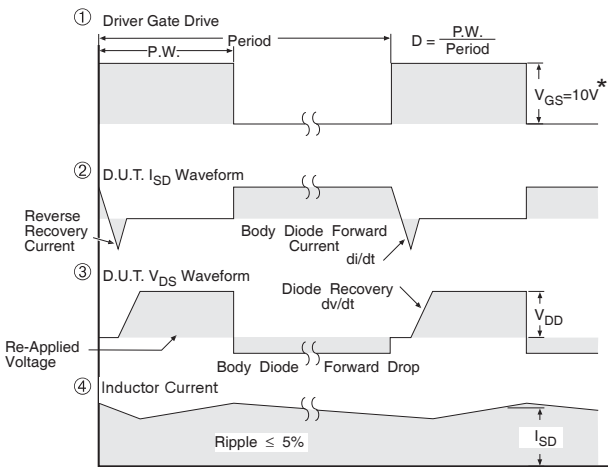
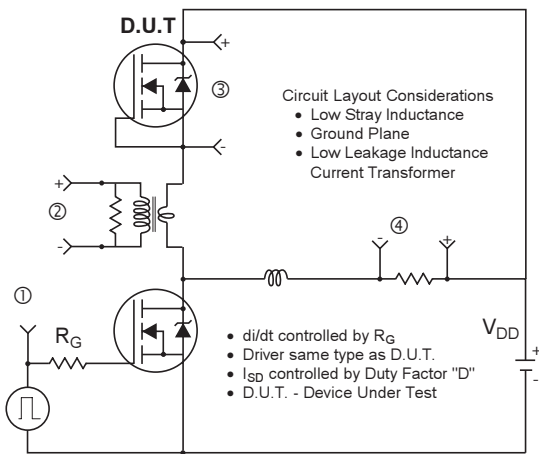

Fig 17. Maximum Effective Transient Thermal Impedance, Junction-to-Case



* $V_{GS} = 5V$ for Logic Level Devices

Fig 18. Diode Reverse Recovery Test Circuit for N-Channel HEXFET[®] Power MOSFETs

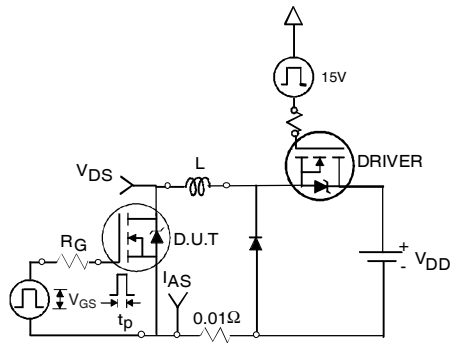

Fig 19a. Unclamped Inductive Test Circuit

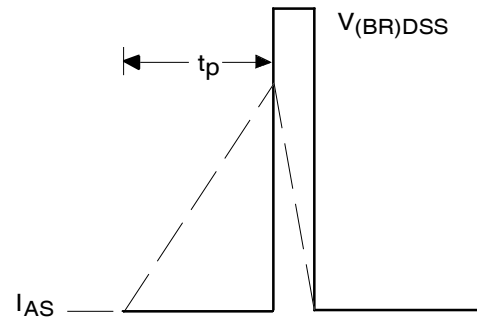

Fig 19b. Unclamped Inductive Waveforms

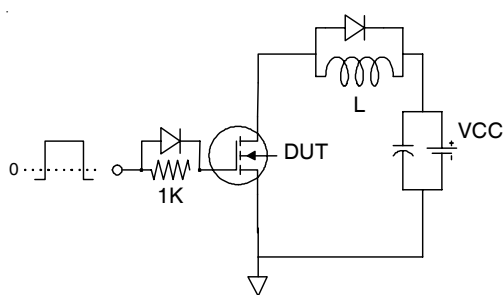

Fig 20a. Gate Charge Test Circuit

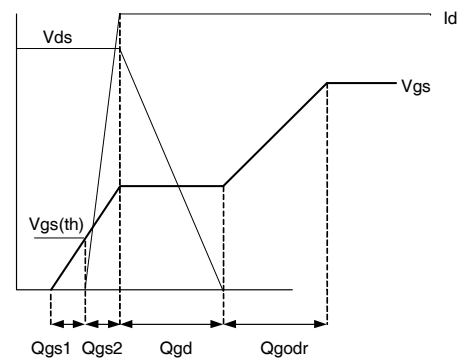

Fig 20b. Gate Charge Waveform

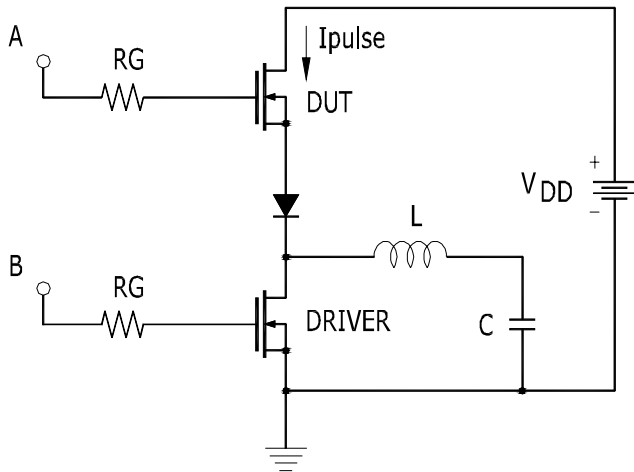

Fig 21a. t_{st} and E_{PULSE} Test Circuit

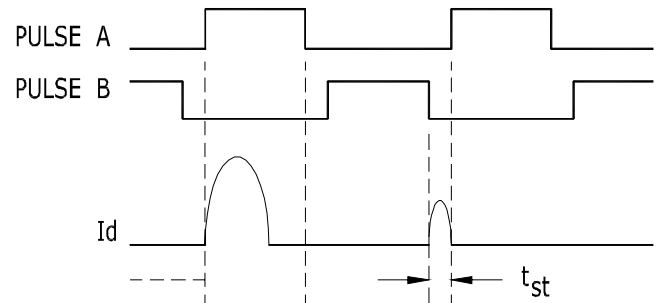

Fig 21b. t_{st} Test Waveforms

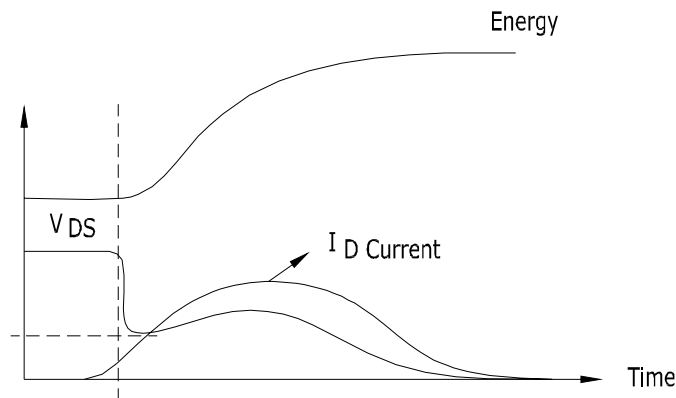

Fig 21c. E_{PULSE} Test Waveforms

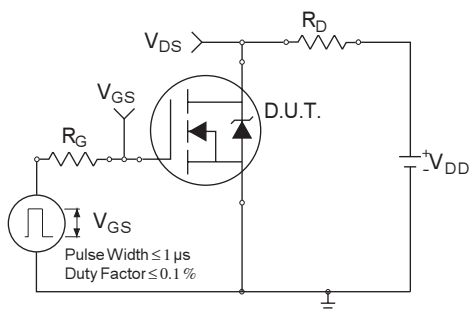

Fig 22a. Switching Time Test Circuit

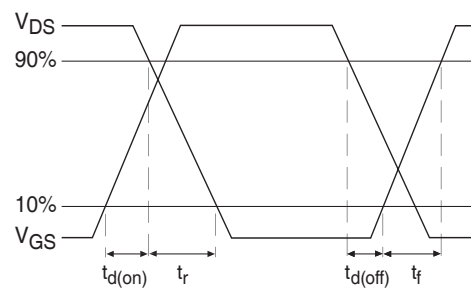
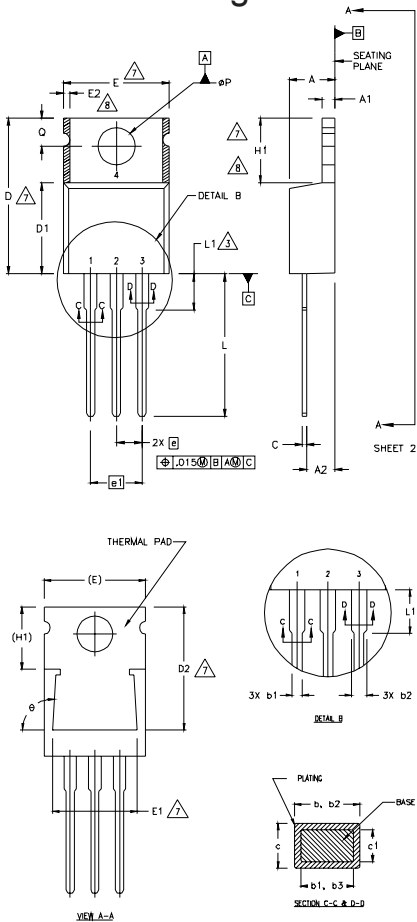

Fig 22b. Switching Time Waveforms

TO-220AB Package Outline (Dimensions are shown in millimeters (inches))



NOTES:

- 1 DIMENSIONING AND TOLERANCING PER ASME Y14.5 M- 1994.
- 2 DIMENSIONS ARE SHOWN IN INCHES [MILLIMETERS].
- 3 LEAD DIMENSION AND FINISH UNCONTROLLED IN L1.
- 4 DIMENSION D & E DO NOT INCLUDE MOLD FLASH. MOLD FLASH SHALL NOT EXCEED .005" (0,127) PER SIDE, THESE DIMENSIONS ARE MEASURED AT THE OUTERMOST EXTREMES OF THE PLASTIC BODY.
- 5 DIMENSION b1 & c1 APPLY TO BASE METAL ONLY.
- 6 CONTROLLING DIMENSION : INCHES.
- 7 THERMAL PAD CONTOUR OPTIONAL WITHIN DIMENSIONS E,H1,D2 & E1
- 8 DIMENSION E2 X H1 DEFINE A ZONE WHERE STAMPING AND SINGULATION IRREGULARITIES ARE ALLOWED.

LEAD ASSIGNMENTS

- HEXKEET**
- 1.- GATE
 - 2.- DRAIN
 - 3.- SOURCE

IGBTs, CoPACK

- 1.- GATE
- 2.- COLLECTOR
- 3.- EMITTER

DIODES

- 1.- ANODE/OPEN
- 2.- CATHODE
- 3.- ANODE

SYMBOL	DIMENSIONS				NOTES
	MILLIMETERS		INCHES		
	MIN.	MAX.	MIN.	MAX.	
A	3,56	4,82	.140	.190	
A1	0,51	1,40	.020	.055	
A2	2,04	2,92	.080	.115	
b	0,38	1,01	.015	.040	
b1	0,38	0,96	.015	.038	5
b2	1,15	1,77	.045	.070	
b3	1,15	1,73	.045	.068	
c	0,36	0,61	.014	.024	
c1	0,36	0,56	.014	.022	5
D	14,22	16,51	.560	.650	4
D1	8,38	9,02	.330	.355	
D2	12,19	12,88	.480	.507	7
E	9,66	10,66	.380	.420	4,7
E1	8,38	8,89	.330	.350	7
e	2,54 BSC		.100 BSC		
e1	5,08		.200 BSC		
H1	5,85	6,55	.230	.270	7,8
L	12,70	14,73	.500	.580	
L1	-	6,35	-	.250	3
ØP	3,54	4,08	.139	.161	
Ø	2,54	3,42	.100	.135	
Ø	90°-93°		90°-93°		

TO-220AB Part Marking Information

EXAMPLE: THIS IS AN IRF1010
 LOT CODE 1789
 ASSEMBLED ON WW 19, 1997
 IN THE ASSEMBLY LINE 'C'
Note: "P" in assembly line position indicates "Lead-Free"

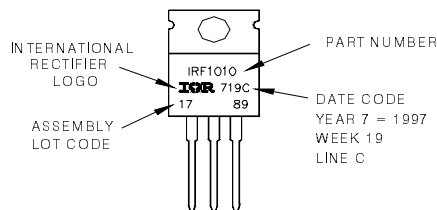

TO-220AB packages are not recommended for Surface Mount Application.

Notes:

- ① Repetitive rating; pulse width limited by max. junction temperature.
- ② Starting $T_J = 25^\circ\text{C}$, $L = 0.34\text{mH}$, $R_G = 25\Omega$, $I_{AS} = 39\text{A}$.
- ③ Pulse width $\leq 400\mu\text{s}$; duty cycle $\leq 2\%$.
- ④ R_θ is measured at T_J of approximately 90°C .
- ⑤ Half sine wave with duty cycle = 0.25, $t_{on} = 1\mu\text{sec}$.

Note: For the most current drawing please refer to IR website at: <http://www.irf.com/package/>

Data and specifications subject to change without notice.
 This product has been designed and qualified for the Industrial market.
 Qualification Standards can be found on IR's Web site.